



---

# DIGIWOLF

**CELL POWERED VERSION**

**4628405**

**4628506**

**4628707**

**CE**

*Software rel. 1.0X*

---

**INSTALLATION, USE AND MAINTENANCE**

## LEGEND SYMBOLS

 = Generic danger

 = Warning

*This manual is an integral part of the equipment to which it refers and must accompany the equipment in case of sale or change of ownership. Keep it for future reference; ARAG reserves the right to modify the specifications and instructions regarding the product at any time and without prior notice.*

<b>1</b>	<b>Product description</b>	<b>4</b>
1.1	Intended use	4
<b>2</b>	<b>Flowmeter assembly</b>	<b>4</b>
2.1	Monitor rotation	5
2.2	Dimensions (mm)	6
2.3	Hydraulic connections	6
2.3.1	<i>Hydraulic connection for brass/fork connections</i>	6
2.4	Power supply	7
2.4.1	<i>Battery replacement</i>	7
<b>3</b>	<b>Controls in the menu</b>	<b>8</b>
	<b>Menu structure</b>	<b>9</b>
<b>4</b>	<b>Preliminary setup for use</b>	<b>10</b>
4.1	Calibration	10
4.1.1	<i>Automatic calibration</i>	10
4.1.2	<i>Manual calibration</i>	11
4.2	Flowrate alarms	12
4.3	Display	12
4.4	Energy saving	13
4.5	Options	13
4.5.1	<i>Language</i>	13
4.5.2	<i>Units of measurement</i>	14
4.5.2.1	<i>Rate units of measurement</i>	14
4.5.2.2	<i>Volume units of measurement</i>	14
4.6	Test	15
4.6.1	<i>Display test</i>	15
4.6.2	<i>Keys test</i>	15
<b>5</b>	<b>Use</b>	<b>16</b>
5.1	Partial totalizer reset	16
<b>6</b>	<b>Cleaning and repair</b>	<b>17</b>
6.1	Troubleshooting	17
6.2	Paddle cleaning and replacement	18
6.3	OR replacement	19
<b>7</b>	<b>Technical data</b>	<b>20</b>
<b>8</b>	<b>Disposal at the end of service</b>	<b>20</b>
<b>9</b>	<b>Guarantee terms</b>	<b>22</b>

# INTRODUCTION

## 1 PRODUCT DESCRIPTION

DigiWolf is a battery powered paddle flowmeter capable of measuring the rate of a fluid in a hydraulic circuit, and it can display the results of these measurements.

### 1.1 Intended use

**CE** This device is designed to work on agricultural machinery for crop spraying applications. The machine is designed and built in compliance with EN ISO 14982 standard (Electromagnetic compatibility - Forestry and farming machines), harmonized with 2014/30/UE Directive.

 The flowmeter must not be used to measure the passage of hydrocarbons, flammable, explosive or toxic liquids. The flowmeter is not suitable for contact with liquids for human consumption.

## 2 FLOWMETER ASSEMBLY

Install the flowmeter **at least 20 cm** from the elements that could cause turbulence inside the tubes (valves, bends, constrictions, etc.). The flowmeter can be installed in a vertical or horizontal position.

 **CAUTION:**  
- Do not install the flowmeter with the connector facing downwards (Fig. 1).  
- The system must have a filtering element with a filter of at least 50 mesh, together with a safety valve to limit use pressure at the specified max. valve (Tab. 2 - Par. 2.3.1).

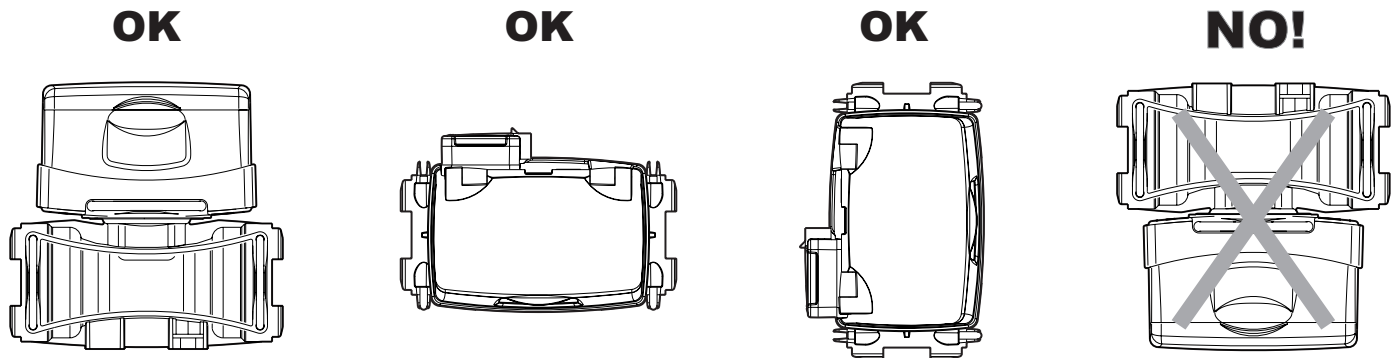

Fig. 1

Assemble the flowmeter using the suitable mounting parts (Fig. 2): fit the bolts (M8) in their seats, then make them slide to their stop position to prevent them from coming out.

 The flowmeter body must be assembled with the arrow on the label facing the flow direction.

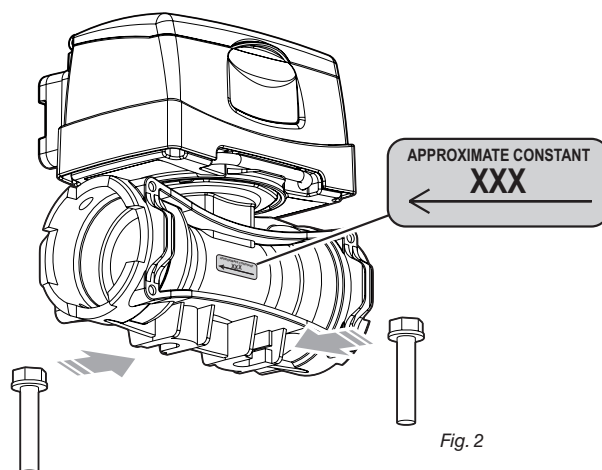
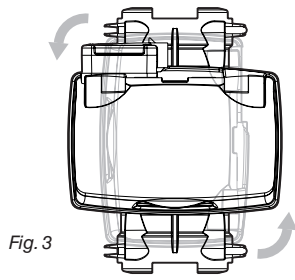
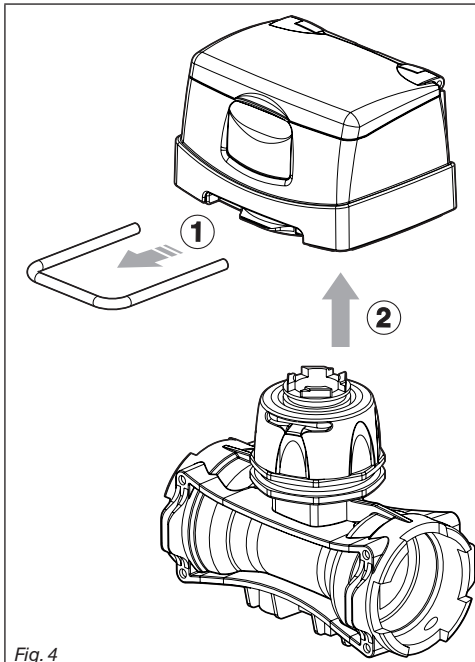

Fig. 2

2.1 Monitor rotation



In case of vertical assembly, to simplify the use of the DigiWolf it is possible to rotate the monitor by 90° with respect to the body (Fig. 3).



- 1) Remove the fork from the monitor using a screwdriver.
- 2) Remove the monitor from the flowmeter body.

Fig. 4



If the monitor is turned upside down, the letters **A** and **B** can be seen: these correspond to the two possible monitor positions (parallel and perpendicular to the body). DigiWolf is supplied with the sensor in position **A** (parallel to the body).

Fig. 5



With the aid of a screwdriver, loosen the screw locking the sensor **without removing it**.

Fig. 6



Rotate the sensor anti-clockwise until reaching **B** stop position.  
Tighten back the screw **without forcing it**. The monitor is ready to be fitted in perpendicular position to the body.  
Fit the monitor back on the flowmeter body.

Fig. 7

# INSTALLATION

## 2.2 Dimensions (mm)

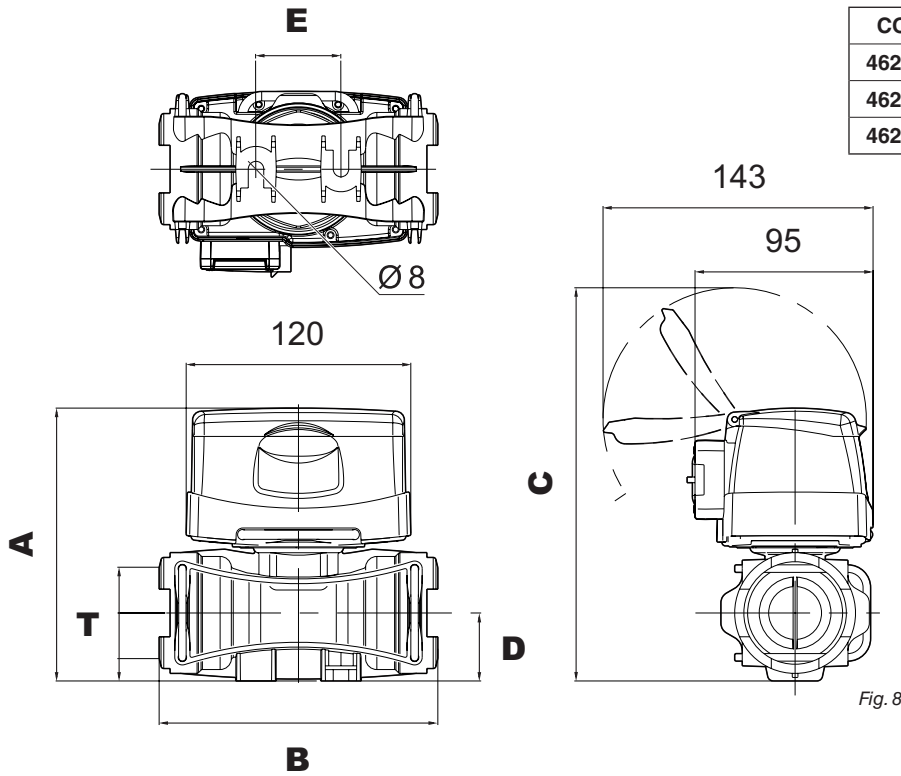

CODE	A	B	C	D	E	T
4628405	140	128	205	31	41	T5
4628506	145	148	210	36	45	T6
4628707	157	162	222	41	45	T7

Tab. 1

Fig. 8

## 2.3 Hydraulic connections

### 2.3.1 Hydraulic connection for brass/fork connections

Avoid bends and constrictions before connections and on tubes.

Use ARAG connections with their suitable OR with MALE CONNECTIONS [T connections - General Catalogue (Tab. 2)].

The tubes must be able to stand a pressure of at least twice the max. operation pressure of the flowmeter (Tab. 2) **CONSIDERING THE OPERATION PRESSURES WITHIN THE SYSTEM.**

Hose tail tightening must be done using the suitable metal clamps to ensure perfect mechanical sealing, even at high pressures. The connection with threaded connectors must be done paying attention to operation pressure.



**CAUTION:** For the implementation on already operating systems it is necessary to follow all safety rules described herein. System assembly and start-up must be carried out by expert personnel according to the safety rules so as to ensure the same safety level of the system the flowmeter is going to be installed in.

After connection, check for the perfect sealing of the tubes and fork connections.

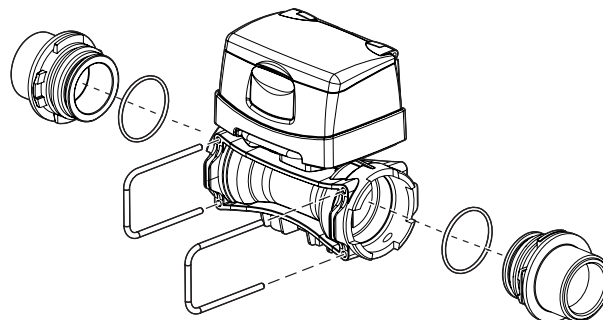





Fig. 9

CODE	 l/min.	 US GPM	Connection	Ø equivalent (inch)	 Max. p (bar)	 Max. p (PSI)
4628405	10-200	2.6-53	T5 F	1 1/4"	20	290
4628506	20-400	5-106	T6 F	1 1/2"	12	174
4628707	40-800	10-210	T7 F	2"	7	130

Tab. 2



The diameter in inches (Ø equivalent) is given only as an indication of the typical passage of the flowmeter body. Actually, it is possible to choose different sizes depending on the fork connection used.

2.4 Power supply

DigiWolf is powered by 2 AA batteries type LR6 (alkaline) or FR6 (Li-Fe S2).

2.4.1 Battery replacement

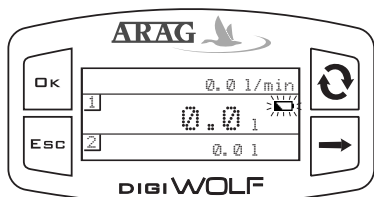

Fig. 10

When the batteries are low, the symbol  will blink on the display.

To insert or replace the batteries, proceed as follows:

- 1) Remove the lid of the battery compartment (A) loosening the 4 screws (B);
- 2) Remove the battery support (C) and replace the batteries, **respecting their polarity (as indicated)**.
- 3) Fit the support back in its housing and refit the lid by tightening the 4 screws **without forcing them**, taking care not to crush or break the wires in the battery case and that the lid seal remains in its seat.

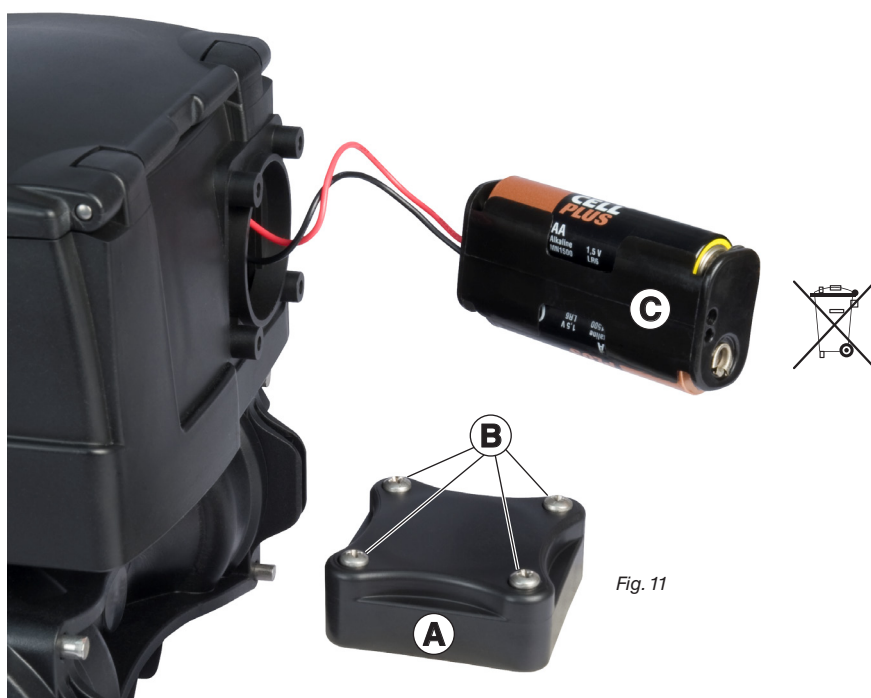

Fig. 11



To avoid damaging the device, replace low batteries as soon as this symbol is displayed .

Remember to remove the batteries when the device is not going to be in use for a long period.

Use only the recommended type of batteries. Do not use combinations of different types of batteries (old and new, carbon and alkaline, etc.). Do not try to recharge the batteries.



ARAG is not liable for damage to the equipment, persons, animals or things caused by failure to observe the above instructions.



Do not dispose of exhausted batteries in the environment. Dispose of in a suitable container.

3 CONTROLS IN THE MENU

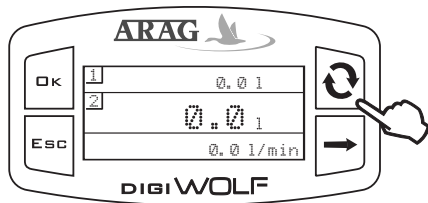

Fig. 12

**SWITCH ON**

The display turns on automatically at liquid passage. If you need to switch on the device to check or modify data, press **OK**.

DigiWolf switches on and displays the figure shown.

Press the key to see the succession of different values written in full (central part of the display).

**At first device switch on, or after battery replacement, the device will briefly display its name and software version.**

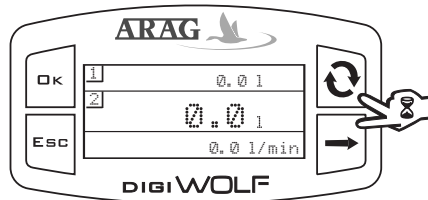

Fig. 13

**ACCESS TO SETUP MENU**

Press the keys for **2 seconds** at the same time to access setup menu.



Fig. 14

**SELECTION AND ACCESS TO MENU ITEMS**

**A** Press in succession to move through items (the selected item is highlighted with a black band)

**B** Press to access the selected item

**Hand icon** Three dots under an item show the presence of another setup menu.



Fig. 15

**MODIFYING DATA**

**A** Press to toggle from one digit to another

**B** Press in succession to modify the value of the digit highlighted by the cursor

**C** Press to confirm the change. The display goes back to the previous screen.

**D** Press to exit current page without confirming changes.



MENU STRUCTURE

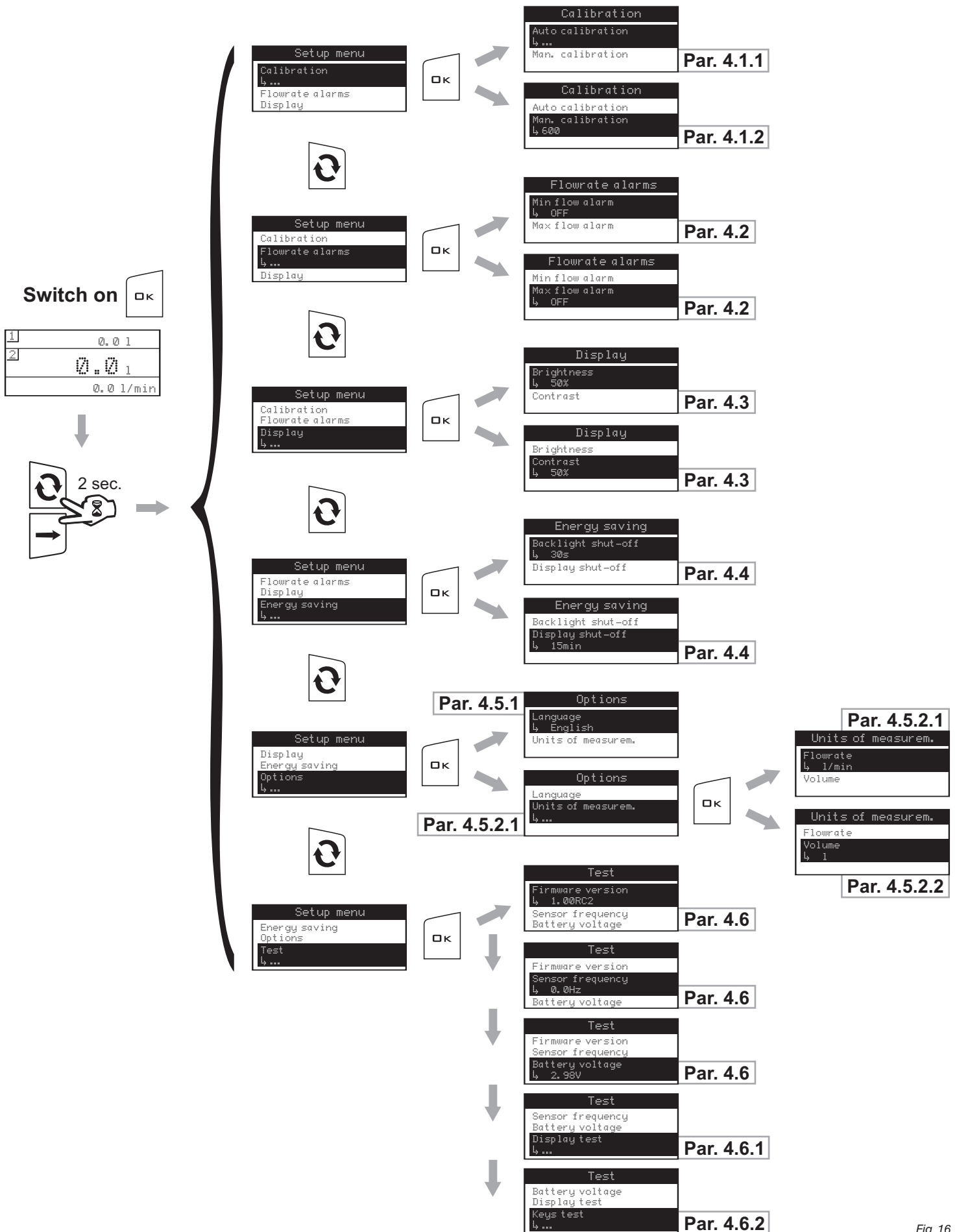

Fig. 16

**4 PRELIMINARY SETUP FOR USE**

For a correct display of data regarding treatment, some preliminary set ups are necessary when installing DigiWolf on farming machines.

**4.1 Calibration**



Rate reading may not be correct due to different system configurations (tubes, valve, etc.). Therefore, we recommend to make a spray test; in case the measured value is different from the real one, perform an automatic calibration procedure or manually calculate flowrate constant.

**4.1.1 Automatic calibration**

Make a quantity of liquid previously measured or that can be measured with another system go through the flowmeter. **The greater the amount of liquid used to perform the calibration procedure, the more accurate the calibration.**

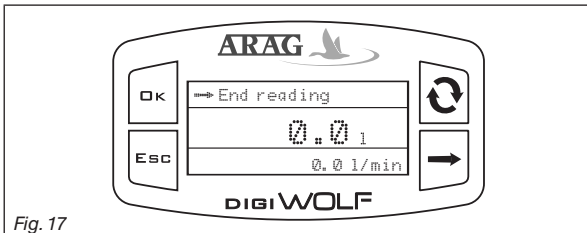

Fig. 17

2) Access Automatic calibration menu (Setup menu > Calibration > Auto calibration). **Once inside the menu, the device is ready to start measuring without any further controls.**

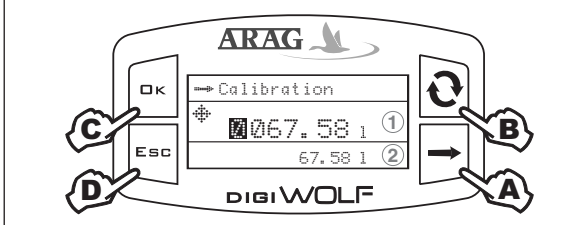

Fig. 18

3) Make the liquid go through the system. The display will start to show the increasing value of the measured quantity of liquid. Once liquid passage has finished, the value on the display will not change any more. At this point, press **OK**. In the lower part of the display, the message **Stabilization** will come up and the device will show the screen on the side.

- ① Setting of liquid amount actually passed through the flowmeter during calibration procedure.
- ② Display of liquid amount read by the flowmeter during calibration procedure.

4) Using the keys, enter the values of the liquid quantity previously measured:

- A) Press to toggle from one digit to another
- B) Press in succession to modify the value of the digit highlighted by the cursor
- C) Press to complete calibration procedure, or D) Press for 1 sec. to cancel calibration procedure.

**If, after starting calibration, the device does not sense any flow passage (and the display remains in 0), press **OK** to exit the calibration procedure without saving.**



**If the device continues to sense the liquid flow after pressing **OK**, after a few seconds the error message **Stop flow!** will be displayed. Once the flow has been interrupted, the reading will stabilize as by standard procedure.**

4.1.2 Manual calibration

To set the flowrate constant manually, calculate and set the correct constant using the following formula:

$$\frac{[\text{amount measured by device}]}{[\text{actually delivered quantity}]} \times [\text{constant indicated on flowmeter body}]$$



Fig. 19

1) Access Manual calibration menu (Setup menu > Calibration > Man. calibration).  
**In Calibration menu, selecting Manual calibration, under the item the currently set constant will be displayed.**  
 Press **OK** to access value modification.



Fig. 20

2) Using the suitable keys, set the value of the flowmeter constant:  
**A)** Press to toggle from one digit to another  
**B)** Press in succession to modify the value of the digit highlighted by the cursor  
**C)** Press to save changes or **D)** Press to exit current page without confirming changes. Refer to the label on the body (Fig. 21).

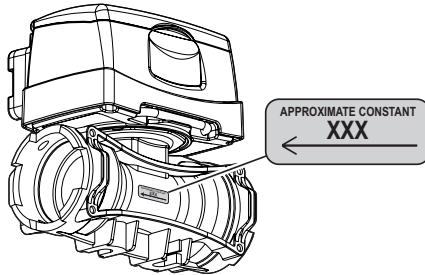



Fig. 21

 **The flowmeter body must be assembled with the arrow on the label facing the flow direction.**

CODE	Approximate constant
4628405	250
4628506	132
4628707	64

Tab. 3

## 4.2 Flowrate alarms

Set the minimum and maximum values beyond which the display must show an alarm message.

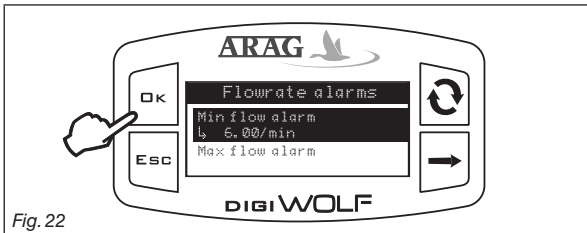

Fig. 22

1) Access Flowrate alarms menu (Setup menu > Flowrate alarms).

**Min. and max. flowrate alarms setting is done in the same way.**

**Under the selected item, the currently set value will be displayed.**

Press **OK** to access modification of the selected item.

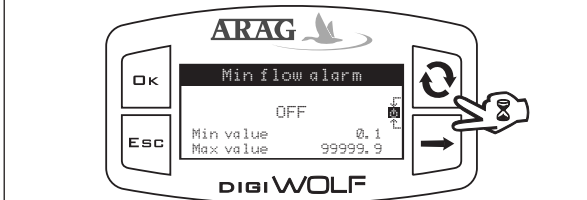

Fig. 23

2) To activate the alarm, press and at the same time until the message **OFF** disappears and flowrate alarm value is displayed.

Carry out the same procedure to deactivate flowrate alarm again.

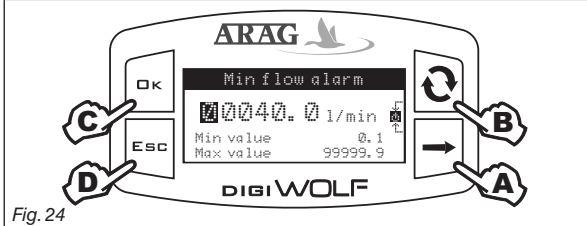

Fig. 24

3) Set flowrate alarm value:

A) Press to toggle from one digit to another

B) Press in succession to modify the value of the digit highlighted by the cursor

C) Press to save changes or D) Press to exit current page without confirming changes.

## 4.3 Display

Adjust display brightness and contrast.

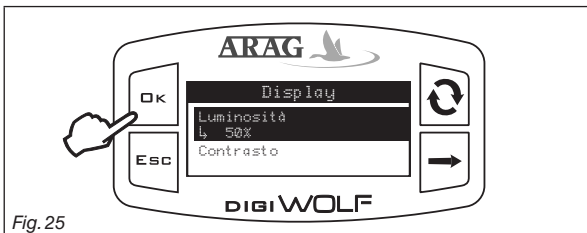

Fig. 25

Access display menu (Setup menu > Display).

**Brightness and contrast adjustment is done in the same way.**

**Under the selected item, the currently set value will be displayed.**

Press **OK** to access modification of the selected item.

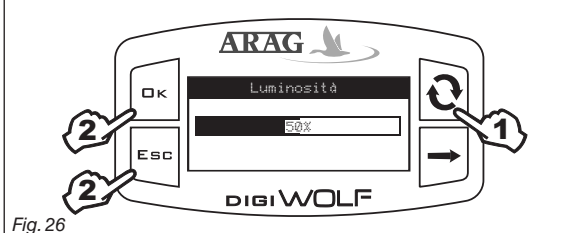

Fig. 26

1) Set the value using the key . Each time it is pressed, the value will increase by 10% until reaching 100%, and then starts back from 0.

2) Press **OK** to save, or **ESC** to exit without saving.

**The brightness value affects battery life: the higher the value, the shorter the battery life.**

4.4 Energy saving

DigiWolf allows the setting of some parameters in order to prolong battery life:



- **Backlight shut-off:**

it is possible to set a time in seconds after which the backlight will turn off automatically if no key is pressed.

- **Display shut-off:**

it is possible to set a time in minutes after which the display will turn off automatically if no key is pressed and there is no liquid flow.



 **After switch off, the display will automatically turn on by pressing any key or when the device detects liquid flow.**

 <p>Fig. 27</p>	<p>1) Access energy saving menu (Setup menu &gt; Energy saving).</p> <p><b>Under the selected item, the currently set value will be displayed.</b></p> <p>Press <b>OK</b> to access modification of the selected item.</p>
 <p>Fig. 28</p>	<p>2) Set the value:</p> <p>A) Press to toggle from one digit to another</p> <p>B) Press in succession to modify the value of the digit highlighted by the cursor</p> <p>C) Press <b>OK</b> to save, or <b>ESC</b> to exit without saving.</p>

4.5 Options

4.5.1 Language

Set desired language and units of measurement.

 <p>Fig. 29</p>	<p>Access language setup menu (Setup menu &gt; Options &gt; Language).</p> <p><b>Under the selected item, the currently set value will be displayed.</b></p> <p>Press <b>OK</b> to access language selection.</p>
 <p>Fig. 30</p>	<p>1) Select language using .</p> <p>2) Press <b>OK</b> to save, or <b>ESC</b> to exit without saving.</p>

## 4.5.2 Units of measurement

Set units of measurement for flowrate values and volume read by the device.

### 4.5.2.1 Rate units of measurement

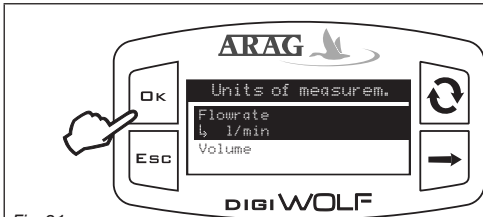

Fig. 31

Access instant rate units of measurement menu (Setup menu > Options > Units of measurem. > Flowrate).

**Under the selected item, the currently set value will be displayed.**

Press **OK** to access flowrate units of measurement selection.

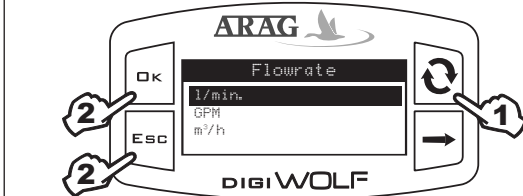



Fig. 32

1) Select measurement unit using .

2) Press **OK** to save, or **ESC** to exit without saving.

### 4.5.2.2 Volume units of measurement

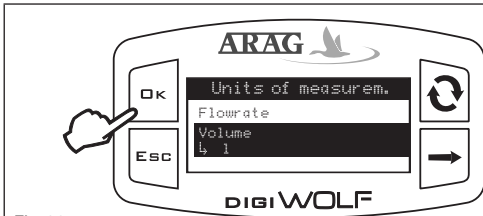

Fig. 33

Access volume units of measurement menu (Setup menu > Options > Units of measurem. > Volume).

**Under the selected item, the currently set value will be displayed.**

Press **OK** to access volume units of measurement selection.

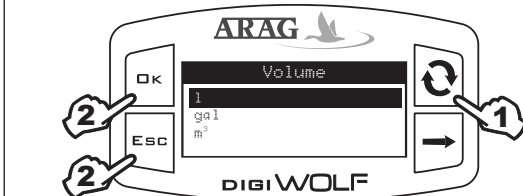



Fig. 34

1) Select measurement unit using .

2) Press **OK** to save, or **ESC** to exit without saving.

4.6 Test

In this menu is it possible to see some information and run a device operation test:

**- Firmware version:**

the display shows the firmware version installed on the device.

**- Sensor frequency:**



in the presence of flow passage, the display shows in real time the frequency of the signal from the sensor reading the flowrate.

**- Battery voltage:**

the display shows the voltage level of the batteries in the device.

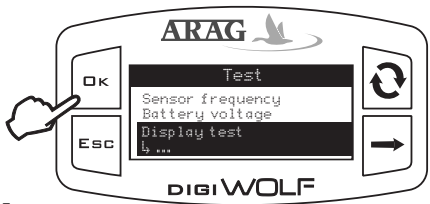

4.6.1 Display test

Display test checks the correct operation of the display on the device.

 <p>Fig. 35</p>	<p>Access display test menu (Setup menu &gt; Test &gt; Display test). Press <b>OK</b>.</p>
 <p>Fig. 36</p>	<p>The display shows all pixels on. Press <b>ESC</b> to return to the previous screen.</p>

4.6.2 Keys test

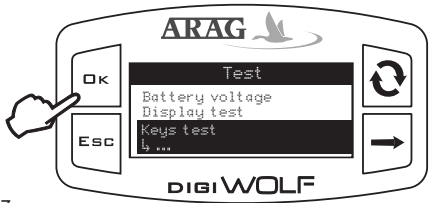
Keys test checks the correct operation of the keys on the device.

 <p>Fig. 37</p>	<p>Access keys test menu (Setup menu &gt; Test &gt; Keys test). Press <b>OK</b> to access the test.</p>
 <p>Fig. 38</p>	<p>1) Pressing one key, the corresponding portion of the display will light up. 2) To exit, press <b>ESC</b>: after lighting up the corresponding portion of the display, it will return to the previous screen.</p>

5 USE

Once the setup is finished, DigiWolf is ready for use. The main screen shows the display divided into three horizontal sectors. The sectors showing the symbols 1 and 2 represent the partial totalizers, individually resettable. The third data represents instant rate value.

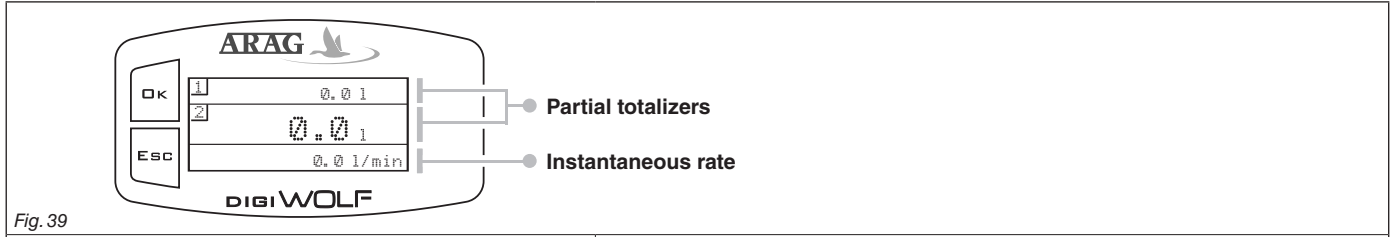

Fig. 39

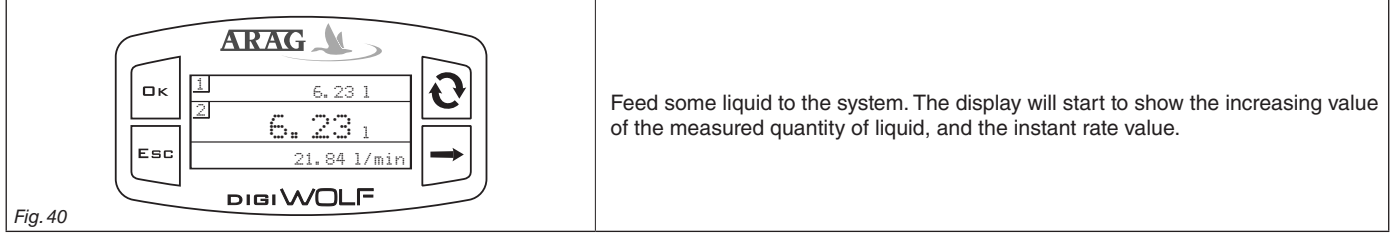

Fig. 40

Feed some liquid to the system. The display will start to show the increasing value of the measured quantity of liquid, and the instant rate value.

5.1 Partial totalizer reset

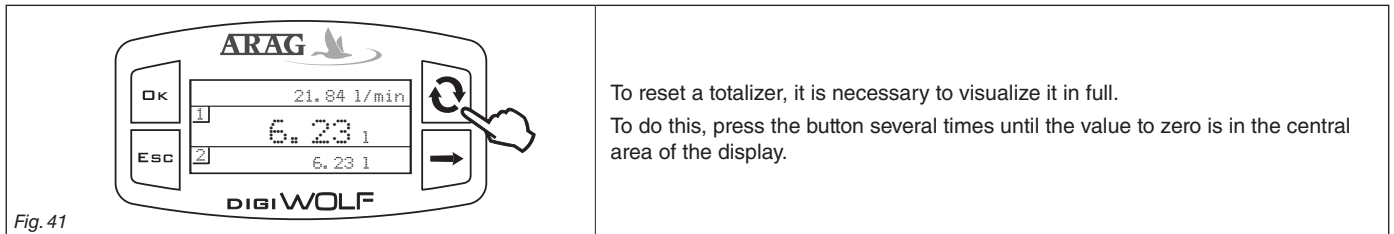

Fig. 41

To reset a totalizer, it is necessary to visualize it in full. To do this, press the button several times until the value to zero is in the central area of the display.

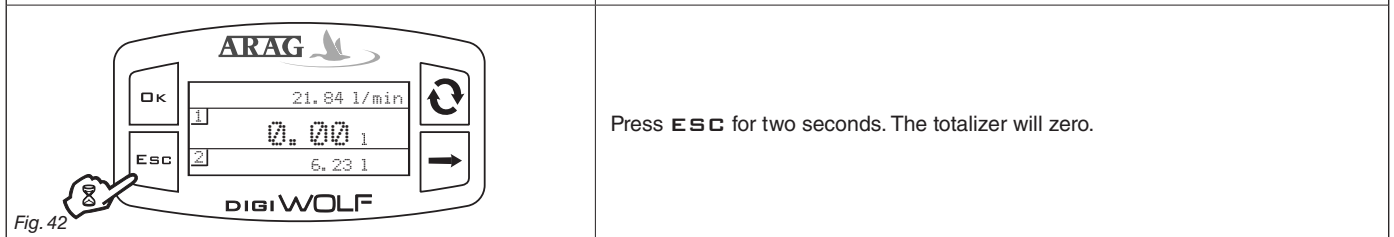



Fig. 42

Press ESC for two seconds. The totalizer will zero.

- Do not place DigiWolf under pressurized water.
- Use the flowmeter only within recommended rate range (Tab. 2 - Par. 2.3.1). Beyond these limits, the flow-meter may give out incorrect data.
- To avoid damaging the flowmeter, do not exceed the maximum rate except for short periods.

 ARAG can not be held responsible for damage caused to persons, animals or things from the incorrect or unintended use of DigiWolf or its parts.

- Do not exceed the max. operation pressure (Tab. 2 - Par. 2.3.1).

 Display of the symbol ----- shows that the rate or the totalizer are over the max. displayable value.

Totalizers have floating points and display a max. of 5 figures. Up to 999.99 two decimals are shown, it then drops to 1 and 0 with the transition to thousands and tens of thousands (Fig. 43).

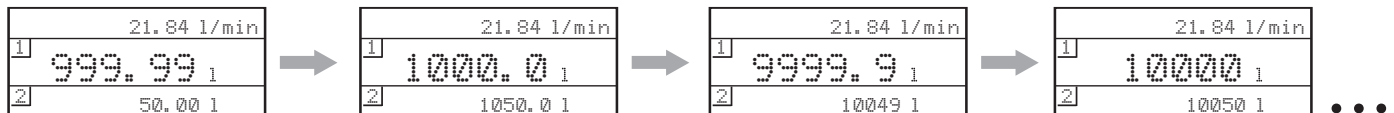

Fig. 43



**6 CLEANING AND REPAIR**

- At the end of each treatment, run clean water through the tubes.
- If necessary, periodically clean or replace the flowmeter paddle (Par. 6.2). Periodically clean the paddle anyway.



**Do not use metal or abrasive objects to clean the paddle.**  
**Do not use solvents or fuel to clean the case outer surface.**



**CAUTION:**  
**Before each of the following operations, use the following precautions:**

- 1) **Wear gloves, goggles and protective clothing.**
- 2) **Stop the machine and disconnect the power of the system.**
- 3) **Make sure that the system is no longer under pressure.**



**When replacing the sensor or the paddle, check for the correct reading of the flowmeter. Proceed to a new calibration if necessary.**

**6.1 Troubleshooting**

<b>FAULT</b>	<b>CAUSE</b>	<b>REMEDY</b>
The display is off	No power supply	<ul style="list-style-type: none"> <li>• Check for the batteries and their correct positioning.</li> <li>• Replace them when necessary.</li> </ul>
Totalizers do not progress during the passage of liquid.	Rate is beyond operation limits of the flowmeter	<ul style="list-style-type: none"> <li>• The model of the flowmeter is not adequate for the flowrate to be measured.</li> <li>• Replace the flowmeter.</li> </ul>
	The sensor is not connected correctly	<ul style="list-style-type: none"> <li>• Check the sensor connection.</li> </ul>
	The paddle-wheel is locked	<ul style="list-style-type: none"> <li>• Clean or replace the paddle-wheel group if necessary.</li> </ul>
Displayed flowrate is not stable	Presence of turbulence or air in the circuit	<ul style="list-style-type: none"> <li>• Check the circuit.</li> </ul>
	Worn paddle	<ul style="list-style-type: none"> <li>• Replace the paddle.</li> </ul>

Tab. 4

## 6.2 Paddle cleaning and replacement

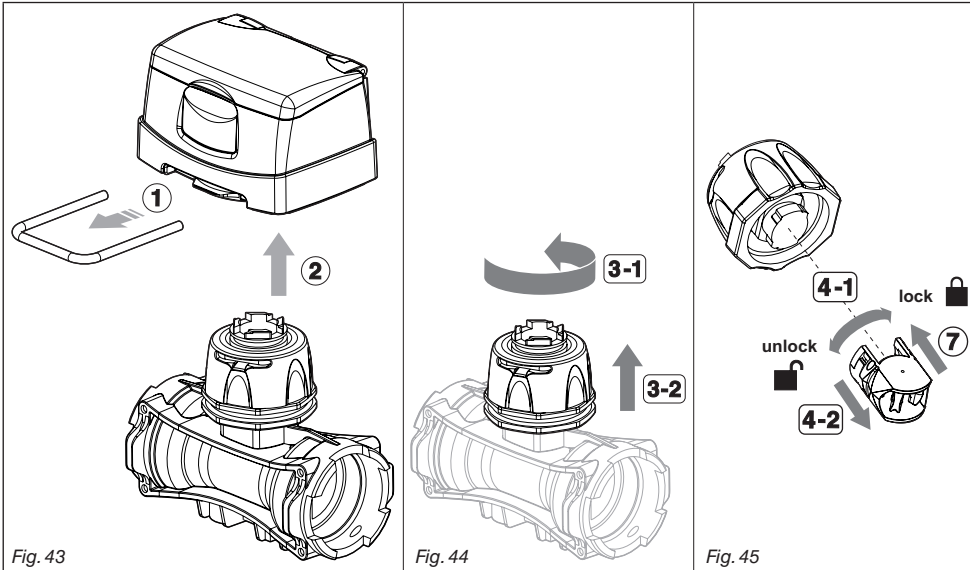

- 1) Remove the fork from the monitor using a screwdriver.
- 2) Remove the monitor from the flowmeter body.
- 3) Unscrew the ring nut in a counter clockwise direction and remove the sensor housing block from the flowmeter body.
- 4) With half a rotation, remove the paddle group from the sensor housing block in a counter clockwise direction.
- 5) Immerse the paddle group in detergent liquid for several hours.
- 6) Wash the paddle group thoroughly with running water and check its correct operation. If necessary, replace the complete paddle group with its suitable spare part (**code 4626000.500**).
- 7) Refit the paddle group on the electronic sensor with a clockwise rotation until it clicks in place.

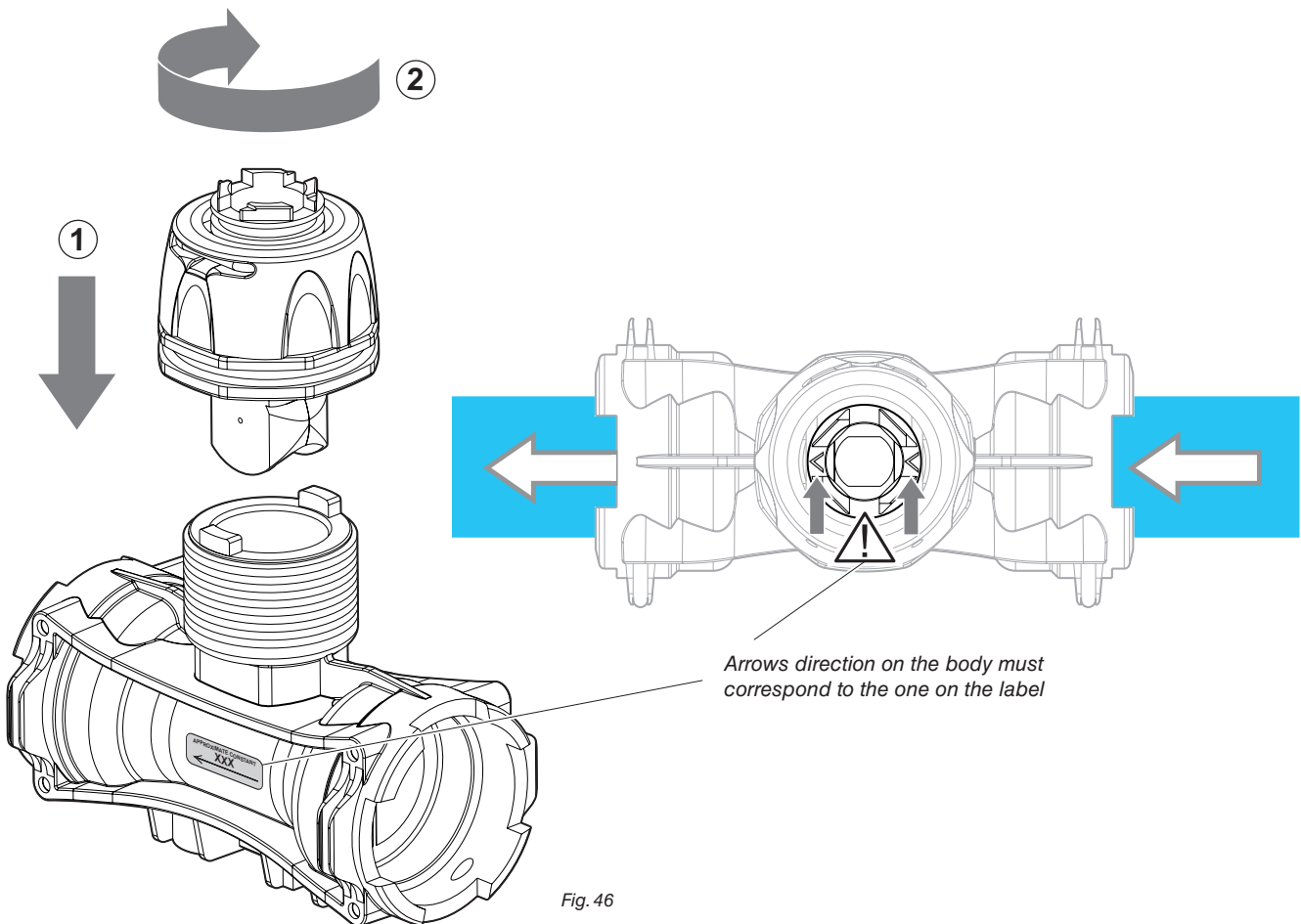

- 8) Refit the sensor housing block on the flowmeter body tightening the ring nut in a clockwise direction until it stops **paying attention to keep the arrow on the coupling facing the flow direction**.

6.3 OR replacement

With the removed sensor housing block (see Par. 6.2) proceed as follows:

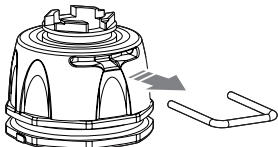
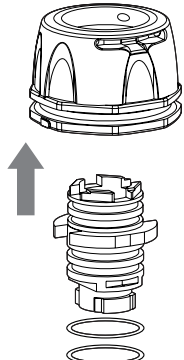
 <p>Fig. 47</p>	<p>1) Remove the fork from the ring nut using a screwdriver.</p>
 <p>Fig. 48</p>	<p>2) Remove the ring nut.</p> <p>- <b>OR replacement:</b> Replace the ORs (code <b>G10051V</b> - ARAG spare parts catalogue).</p> <p>3) Refit the sensor housing block ensuring that the fork is correctly inserted in the ring nut.</p>

## TECHNICAL DATA

	Data	Min.	Max.	Default	UoM	Notes
<b>Calibration</b>	Manual calibration	1	50,000	600	--	--
<b>Flowrate alarms</b>	Min. flowrate alarm	0.1	99999.9	OFF	l/min.	The alarm can be deactivated setting the value "OFF"
	Max. flowrate alarm	0.1	999999.9	OFF	l/min.	The alarm can be deactivated setting the value "OFF"
<b>Display</b>	Brightness	0%	100%	50%	%	--
	Contrast	0%	100%	50%	%	--
<b>Energy saving</b>	Backlight shut-off	1 sec.	300 sec.	30 sec.	sec.	
	Display shut-off	1 min.	120 min.	15 min.	min.	
<b>Options</b>	Language	-	-	English	-	<b>Language settings:</b> Italiano, English, Español, Português, Français, Deutsch, Cesky, Polski, 日本語, Русский, Magyar.
	Rate units of measurement	-	-	l/min.	-	<b>Units of measurement settings:</b> l/min, GPM, m <sup>3</sup> /h
	Volume units of measurement	-	-	litres	-	<b>Units of measurement settings:</b> l, gal, m <sup>3</sup>

Tab. 5

## 7 TECHNICAL DATA

Description	DigiWolf
Power supply	2 AA batteries type LR6 (alkaline) or FR6 (Li-Fe S2)
Max. absorption	40 mA (100% backlight) 4.7uA (standby)
Working temperature	0 °C ÷ 50 °C +32 °F ÷ +122 °F
Storage temperature	0 °C ÷ 50 °C / +32 °F ÷ +122 °F (inserted batteries) -30 °C ÷ 80 °C / -22 °F ÷ +176 °F (without batteries)
Weight (without batteries)	680 ÷ 750 g (depending on the type)

Tab. 6

## 8 DISPOSAL AT THE END OF SERVICE

Dispose of the system in compliance with the established legislation in the country of use.



1. ARAG s.r.l. guarantees this apparatus for a period of 360 day (1 year) from the date of sale to the client user (date of the goods delivery note).

The components of the apparatus, that in the unappealable opinion of ARAG are faulty due to an original defect in the material or production process, will be repaired or replaced free of charge at the nearest Assistance Centre operating at the moment the request for intervention is made. The following costs are excluded:

- disassembly and reassembly of the apparatus from the original system;
  - transport of the apparatus to the Assistance Centre.
2. The following are not covered by the guarantee:
    - damage caused by transport (scratches, dints and similar);
    - damage due to incorrect installation or to faults originating from insufficient or inadequate characteristics of the electrical system, or to alterations resulting from environmental, climatic or other conditions;
    - damage due to the use of unsuitable chemical products, for spraying, watering, weedkilling or any other crop treatment, that may damage the apparatus;
    - malfunctioning caused by negligence, mishandling, lack of know how, repairs or modifications carried out by unauthorised personnel;
    - incorrect installation and regulation;
    - damage or malfunction caused by the lack of ordinary maintenance, such as cleaning of filters, nozzles, etc.;
    - anything that can be considered to be normal wear and tear.
  3. Repairing the apparatus will be carried out within time limits compatible with the organisational needs of the Assistance Centre.

No guarantee conditions will be recognised for those units or components that have not been previously washed and cleaned to remove residue of the products used.
  4. Repairs carried out under guarantee are guaranteed for one year (360 days) from the replacement or repair date.
  5. ARAG will not recognise any further expressed or intended guarantees, apart from those listed here.

No representative or retailer is authorised to take on any other responsibility relative to ARAG products.

The period of the guarantees recognised by law, including the commercial guarantees and allowances for special purposes are limited, in length of time, to the validities given here. In no case will ARAG recognise loss of profits, either direct, indirect, special or subsequent to any damage.
  6. The parts replaced under guarantee remain the property of ARAG.
  7. All safety information present in the sales documents regarding limits in use, performance and product characteristics must be transferred to the end user as a responsibility of the purchaser.
  8. Any controversy must be presented to the Reggio Emilia Law Court.

---

**10 CONFORMITY DECLARATION**

---

The declaration of conformity is available at [www.aragnet.com](http://www.aragnet.com), in the relevant section.

---

*Only use genuine ARAG accessories or spare parts to make sure manufacturer guaranteed safety conditions are maintained in time. Always refer to the internet address [www.aragnet.com](http://www.aragnet.com)*

06/2011

D20246\_GB-m01



42048 RUBIERA (Reggio Emilia) - ITALY

Via Palladio, 5/A

Tel. +39 0522 622011

Fax +39 0522 628944

<http://www.aragnet.com>

[info@aragnet.com](mailto:info@aragnet.com)